



**OFFICIAL MINUTES OF THE OXFORD MAYOR AND COUNCIL MEETING
WORK SESSION
MONDAY, JANUARY 21, 2025 – 6:30 PM
CITY HALL**

ELECTED OFFICIALS PRESENT:

David Eady - Mayor
George Holt – Councilmember
Jim Windham – Councilmember
Laura McCanless – Councilmember
Jeff Wearing – Councilmember
Mike Ready – Councilmember
Erik Oliver – Councilmember

STAFF PRESENT:

Marcia Brooks –City Clerk/Treasurer
Bill Andrew – City Manager
Mark Anglin – Police Chief
Jody Reid – Supervisor of Maintenance and
Utilities
David Strickland – City Attorney

OTHERS PRESENT: Nick Cole, Kate Verity (Covington News)

Agenda (Attachment A)

1. Mayor’s Announcements

Bill Andrew reviewed items in his project status report that had been sent to the City Council.

2. Committee Reports

- a. **Trees, Parks, and Recreation Board** – Mike Ready provided the report.
- b. **Planning Commission** – No report.
- c. **Downtown Development Authority** – No report.
- d. **Sustainability Committee** – No report.

3. Emory Street Stormwater Improvements (Attachment B)

Bill Andrew reviewed the materials provided showing the proposed repairs. One change is that they will not be addressing any stormwater issues on private property; they will need to be addressed by the homeowner. As indicated in the materials, the corrective action will cost \$49,226.78.

4. Discussion of House Bill 581 (Appendix C)

Mayor Eady summarized the purpose of House Bill 581. The State is trying to reduce the rate at which valuations increase for owner occupied residences. Part of the burden of meeting the costs of operation would shift to renters and to owners of commercial and industrial properties. They have done this by creating a “floating homestead exemption” which will cap the rate at which valuations can increase based on the Consumer Price Index (CPI). It would not go higher than 3%. This would start with the 2024 valuations. This provision was on the ballot in November and passed.

Oxford would be impacted by this because it would limit the City’s ability to keep the millage rate at the current rate and allow the increases in valuation with the market to cover increases in operating costs. If inflation were to rise higher than the maximum allowed, Oxford would be required to raise its millage rate and/or cut costs to meet its budgetary needs.

However, the bill also provides for an additional 1% sales tax (FLOST) for the county if all municipalities within the county and the county itself agree to opt in to the State’s rate. The 1% sales tax must be approved by the voters in the county. This sales tax would help offset the limiting effects of opting in to the State’s rate. The economic impact of opting in would be to shift the burden of covering the difference in cost from a value-based tax to a regressive tax.

Jim Windham asked what the impact would be of the City opting out. Laura McCanless stated her understanding is property values would increase with the market like they do now rather than with the rate of inflation. Mayor Eady agreed that if Oxford opts out, the status quo would prevail. Ms. McCanless stated she feels like opting in would benefit homeowners on limited incomes who have struggled with paying their property taxes.

Mayor Eady stated the City could increase the millage rate and create a new homestead exemption for homeowners who live in their primary properties.

George Holt expressed his belief that the City should opt in. Doing so would benefit homeowners.

Mike Ready stated he is not in favor of opting in. He feels it would be harmful to the City as a whole.

Mayor Eady is skeptical whether a 1% sales tax will pass, but if it did, he believes using more sales tax to cover City expenses is not beneficial. He believes additional money should be raised through property tax increases (via millage rate increases).

Mayor Eady summarized the issue: as costs to run the general government increase, is the City willing to make the tough choice to raise the millage rate to cover increases in costs if the City opts in?

Mr. Wearing indicated he believes the City should opt out in order to maintain more control over property taxes.

Laura McCanless stated that Oxford only controls 18% of the total assessment of property taxes.

Mayor Eady recommended holding the hearings while the City Council contemplates what would be best for the City. Not having the hearings would preclude Oxford from opting out.

5. Task Order from AtkinsRealis for Pedestrian Lighting on Whatcoat Street (Appendix D)

There is money in the budget for lighting construction for the Whatcoat Street project, but lighting design was not included in the project plans because AtkinsRealis was not asked to include it. The task order for \$20,000 is to have AtkinsRealis develop the lighting design for pedestrian streetlamps on George Street and Whatcoat Street. The same lights would be used as were used with the Emory Street sidewalks. The cost for the design would be in addition to the \$250,000 for construction.

The City Council will vote on the issue at the February regular session.

6. Reprint of the book, Deep Running Roots, Far-Reaching Branches (Appendix E)

There was consensus from the City Councilmembers to get the book to the point that the City is ready to get a printing quote. Erik Oliver also recommended selling copies as opposed to giving them away.

7. Alignment for Old Church to Hull Street Trail (Attachment F)

Bill Andrew reviewed the slides provided to the City Council. Alternative routes for the Old Church to Hull Street trail were provided due to difficulties that have been encountered with easements and resistance from property owners. There are time restrictions with the grant that necessitate making a decision on this issue soon.

A discussion was held concerning the street work required to complete one of the alternative plans. This work would be an additional cost of about \$400,000. This work was not contemplated in the grant funds or in the original cost estimate. Alternatively, relocation of utilities rather than street work might save some money. Bill Andrew was asked to set up a special called work session with the AtkinsRealis engineers to walk the proposed trails, then discuss the options in another work session.

8. Improvements at Asbury Street Park (Attachment G)

Erik Oliver suggested speaking to Jim Williams of Designed Installations about creating some rock walls for seating. He will work on some concepts for seating. Several suggestions were made for pavilion sound attenuation. Mayor Eady asked

Bill Andrew to contact AtkinsRealis to see if they have any sound experts. Mayor Eady feels that professional help is needed to address the park green issues.

9. Other Business

None.

10. Work Session Meeting Review

11. Executive Session

None

12. Adjourn

Mayor Eady adjourned the meeting at 9:12 pm.

Respectfully Submitted,



Marcia Brooks
City Clerk/Treasurer

Oxford Mayor and Council
Work Session
Tuesday, January 21, 2025 – 6:30 P.M.
Oxford City Hall
110 W. Clark Street, Oxford, Georgia
Agenda

1. **Mayor’s Announcements:** The City and AtkinsRéalis will be hosting an Open House for the 3 Trails Project on February 26 (Wednesday) at 6:30 p.m. here at City Hall.
2. **Committee Reports:** The Trees, Parks and Recreation Board, Planning Commission, Downtown Development Authority, and the Sustainability Committee.
3. ***Emory Street Stormwater Improvements:** During the August Work Session, the Council was informed of the flooding occurring at the corner of Emory St. and E. Wade St. Keck & Wood was authorized to create a plan to correct the situation, which is attached. This plan will address the water flow at 6154 Emory St, the angle of the sidewalk, the undersized pipe and the need for a drop inlet.
4. ***Discussion of House Bill 581:** Through the passage of HB 581 there is now a statewide floating homestead exemption for all local governments. A floating homestead is a special type of homestead exemption designed to offset or reduce increases in taxable value to the property. If Oxford chooses to opt out of the floating homestead, it must do so by a resolution filed with the Secretary of State by March 1, 2025. The opt-out process would require three public hearings.
5. ***Discussion of the Task Order (TO) from AtkinsRéalis for Pedestrian Lighting on Whatcoat Street:** Through this TO, AtkinsRéalis would revise the Whatcoat Street design plans to incorporate the street and pedestrian lighting in a similar fashion with what has been installed on Emory Street. Peach State is operating under a bid of \$620,864 with an additional \$99,000 in construction contingency. This bid includes a lighting construction allowance of \$250,000. The AtkinsRéalis \$20,000 TO is a not to exceed price.
6. ***Discussion of a Reprint of the book, Deep Running Roots, Far-Reaching Branches:** The 2014 edition was mistakenly published with several errors. There has been interest to reformat the book, correct the errors, and update the text for a new edition. Staff are putting together a meeting of Ms. Louise Eady, Ms. Lisa Dorward, Mr. Erik Oliver and Mr. Bill Andrew to discuss the parameters of the project. Staff are seeking guidance on the budget for this effort.
7. ***Discussion of Alignment for The Old Church to Hull Street Trail:** The period of performance for the \$2.2M Georgia OPB grant ends 12/31/2026. Under this grant, all grantees must expend their funds by 10/31/26 and submit their expenses by 12/31/26. Staff and engineering are concerned about the need to consider an alternate route for The Old Church to Hull Street trail.

8. ***Discussion of Improvements at Asbury Street Park:** The FY 2025 capital budget has the following items budgeted: Playground canopy and benches – \$60,000; Pavilion sound buffering – \$10,000; and Park Green repair – \$75,000. Staff are seeking guidance to proceed with these projects.
9. **Other Business:**
10. **Work Session Meeting Review:** Mayor Eady will review all the items discussed during the meeting.
11. **Executive Session:** An Executive Session could potentially be held for Land Acquisition/Disposition, Addressing Pending or Potential Litigation, and/or Personnel.

*Attachments



OPEN HOUSE

WEDNESDAY 2/26/25

6:30 PM TO 7:30 PM

Oxford City Hall

110 W. Clark Street, Oxford, GA 30054

The City of Oxford is planning to construct three bicycle/pedestrian trails in Oxford. Attendance at this meeting will enable you to learn more and share your thoughts.

Areas of trail development include:

- 1) E. Bonnell Street to Keegan Court
- 2) W. Bonnell Street to Cousins Middle School
- 3) Old Church Trail to Hull Street

This project is funded by a \$2.2 million grant from the Governor's Office of Planning and Budget and a match of \$1.3 million by the City of Oxford.

For more information, please contact:

Bill Andrew, City Manager - bandrew@oxfordgeorgia.org
Or (770) 786-7004

208 Emory Street (SR 81)
Stormwater Issues

Water off 6154 Emory St. The 4.2 acre Ballard Property, is emptying onto the sidewalk by their driveway.



Stormwater is being conveyed down Emory Street by the sidewalk.





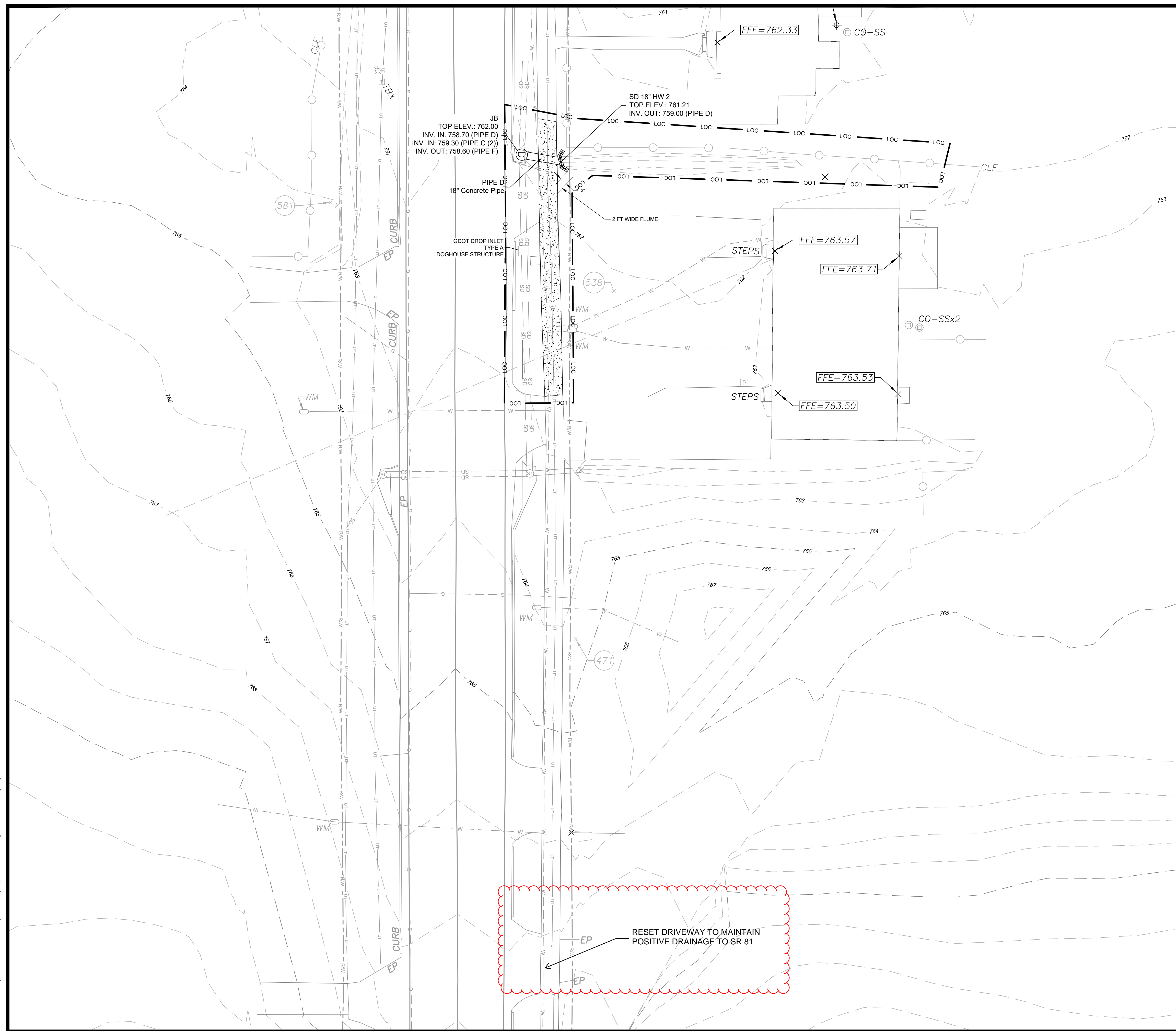

- GENERAL NOTES:
1. THE CONTRACTOR SHALL NOTIFY THE CITY OF OXFORD PROJECT MANAGER OF ANY DISCREPANCIES BETWEEN THE SURVEY SHOWN IN THESE PLANS AND FIELD CONDITIONS BEFORE PROCEEDING WITH ANY NEW CONSTRUCTION.
 2. CONTRACTOR IS RESPONSIBLE FOR CORRECT HORIZONTAL AND VERTICAL ALIGNMENT OF ALL TIE-INS BETWEEN PROPOSED AND EXISTING PAVEMENTS, INCLUDING BUT NOT LIMITED TO, SIDEWALKS, CURBS, GUTTERS, UTILITIES, AND WALLS.
 3. CONTRACTOR TO ENSURE A SMOOTH TRANSITION BETWEEN EXISTING AND PROPOSED SURFACES.
 4. PROOF ROLLS WILL BE REDONE IF THE PROJECT IS RAINED ON BEFORE ANY CONCRETE, STONE, OR ASPHALT IS PLACED.
 5. UNDERCUTTING UNSUITABLE MATERIAL IS ACCEPTABLE, USING ONLY APPROVED FILL.
 6. ANY CHANGES MUST BE APPROVED BY THE CITY OF OXFORD PROJECT MANAGER.
 7. GEOTECHNICAL ENGINEER, PROVIDED BY THE CONTRACTOR, SHALL HAVE FINAL DECISION ON PROOF ROLLS.
 8. ALL BUFFERS, TREE SAVE AREAS, AND UNDISTURBED AREAS SHALL BE CLEARLY IDENTIFIED BY FLAGGING AND/OR FENCING PRIOR TO COMMENCEMENT OF ANY LAND DISTURBING ACTIVITIES.
 9. ALL EROSION AND SEDIMENT CONTROL MEASURES AND TREE PROTECTION MEASURES ARE TO BE INSTALLED PRIOR TO ANY LAND DISTURBING ACTIVITIES.
 10. MAXIMUM FILL/CUT SLOPES SHALL BE 2H:1V.
 11. 24-HOUR CONTACT: ANDREW, BILL (770) 786-7004

LEGEND

PROPOSED CONCRETE SIDEWALK

LOC LIMITS OF CONSTRUCTION (TYP.)

NO.	DATE	REVISION

Emory Street Drainage Improvements
 Oxford, Georgia
SITE PLAN

THIS BAR IS 1 INCH LONG PLOTTED FULL SCALE

Project Manager: _____
 Drawn By: **TM** Checked By: _____
 Date: --/--
 Scale: As Shown

Project No.: **240349**
 Drawing No.: **C-3.0**

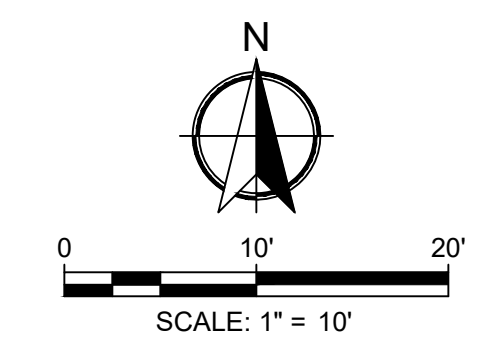

This drawing and the design shown are the property of Keck & Wood, Inc. The reproduction, copying or other use of this drawing without written consent is prohibited and any infringement will be subject to legal action.
 © 2021 Keck & Wood, Inc.

PRELIMINARY

© Shared Drive\2024\Projects\240349 - Oxford - 208 Emory Street Drainage Improvements\240349-Oxford Drainage.dwg

NO.	DATE	REVISION

Emory Street Drainage
 Improvements
 Oxford, Georgia

GRADING & DRAINAGE PLAN

THIS BAR IS 1 INCH LONG PLOTTED FULL SCALE	
Project Manager:	---
Drawn By:	Checked By:
TM	---
Date:	--/--
Scale:	As Shown
Project No.:	240349
Drawing No.:	C-4.0

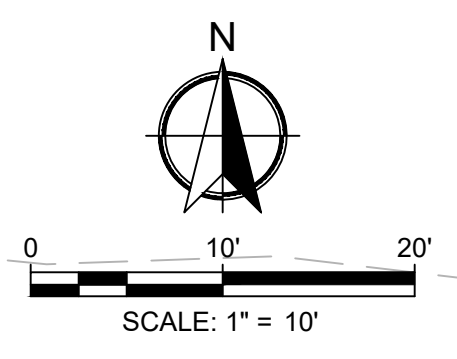
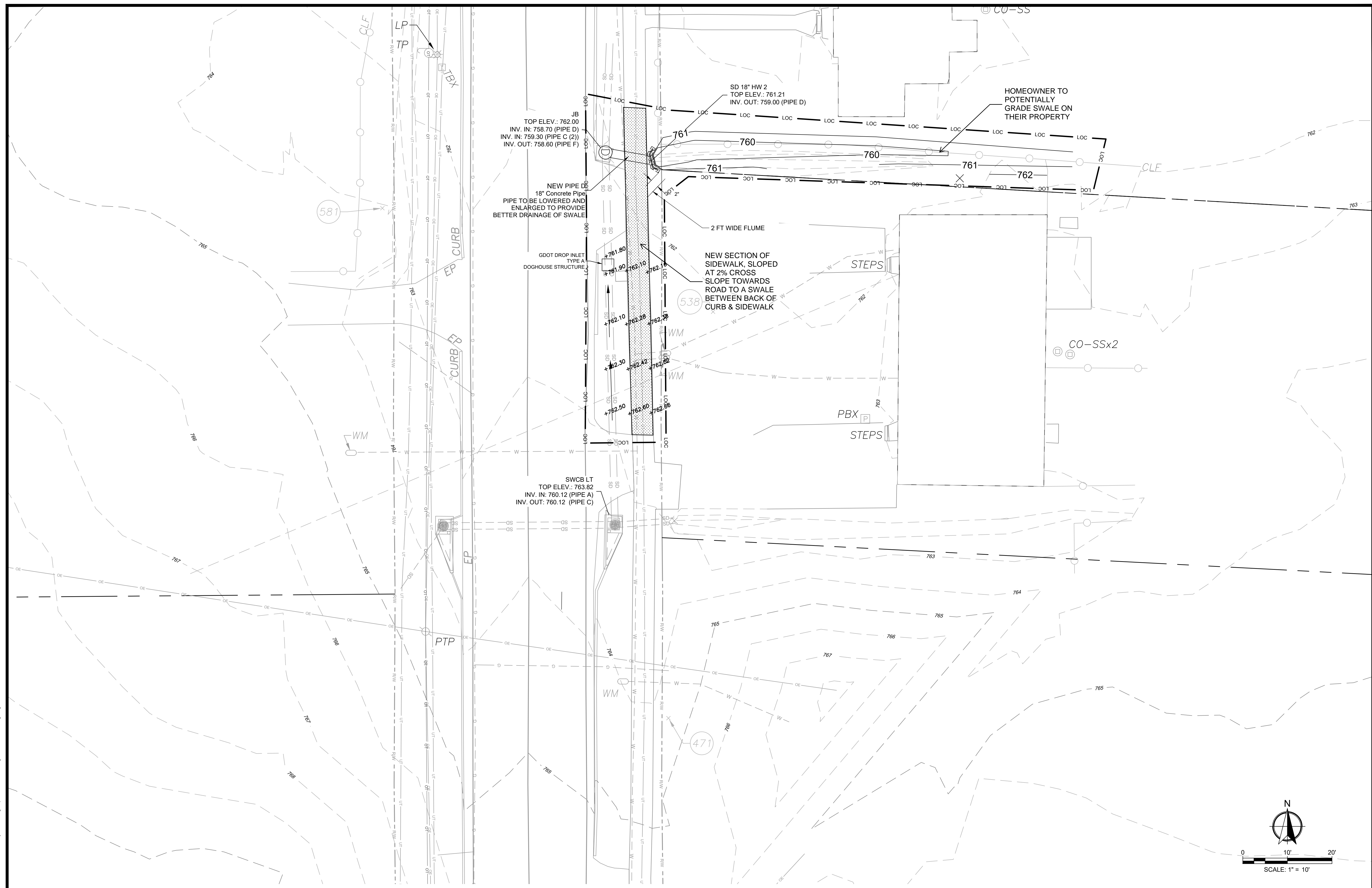

This drawing and the design shown are the property of Keck & Wood, Inc. The reproduction, copying or other use of this drawing without written consent is prohibited and any infringement will be subject to legal action.
 © 2021 Keck & Wood, Inc.

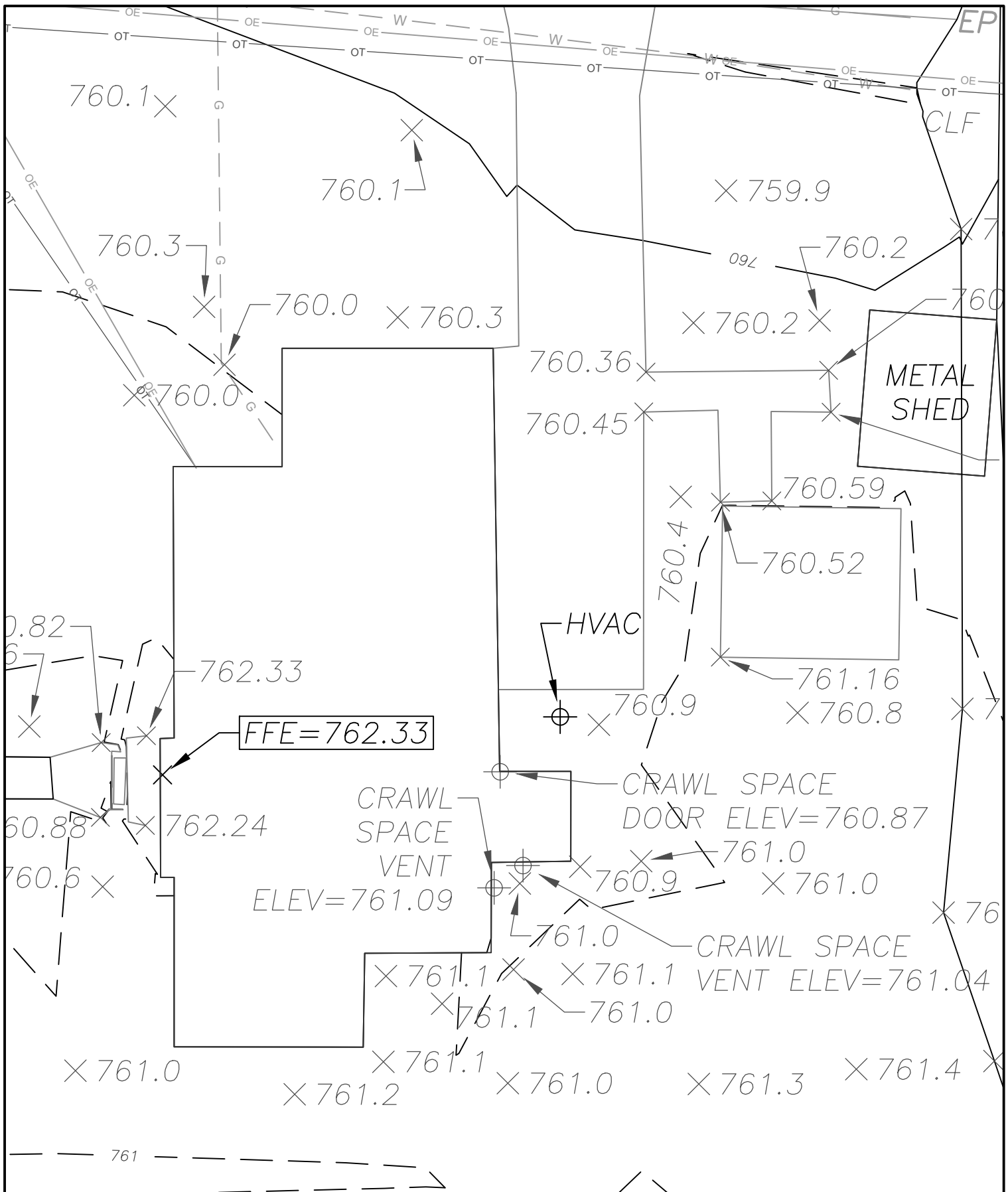

SCALE:	1" = 10'
CHECKED BY:	JO
DRAWN BY:	TM
DATE:	04/25/2024

keck+Wood
 COLLABORATION BY DESIGN
keckwood.com

**Emory Street
 Drainage Improvements**
 OXFORD, GA
 PROPERTY SPOT ELEVATIONS

JOB NUMBER: 240349

EXHIBIT
B



DESCRIPTION: Oxford Drainage Improvement Project
 PROJECT NO.: 240349
 DATE: 1/17/2025
 PREPARED BY: JRO

Item No.	Item	Unit	Quantity	Unit Price	Amount
Startup and Temporary Cost					
1	Grading Complete	LS	1	\$6,204.46	\$6,204.46
2	Mobilization	LS	1	\$10,000.00	\$10,000.00
3	Traffic Control	LS	1	\$722.85	\$722.85
Site					
4	CONC SIDEWALK, 4 IN	SY	50	\$70.00	\$3,500.00
5	DRIVEWAY CONCRETE, 6 IN TK	SY	30	\$85.00	\$2,550.00
Storm System					
6	RECONSTRUCT JUNCTION BOX	EA	1	\$4,500.00	\$4,500.00
7	DROP INLET, GP 1	EA	1	\$5,400.00	\$5,400.00
8	RCP STORM PIPE, 18 IN	LF	10	\$90.00	\$900.00
9	CONC SPILLWAY, TP 3	EA	1	\$3,600.00	\$3,600.00
10	SAFETY END SECTION 18 IN, STORM DRAIN, 4:1 SLOPE	EA	1	\$1,500.00	\$1,500.00
Striping and Signage					
11	RESET HIGHWAY SIGN	EA	1	\$250.00	\$250.00
Erosion Control					
12	SOD	SY	35	\$15.00	\$525.00
13	CONSTRUCT AND REMOVE INLET SEDIMENT TRAP	EA	1	\$260.00	\$260.00
14	MAINTENANCE OF INLET SEDIMENT TRAP	EA	1	\$110.00	\$110.00
15	TEMPORARY SILT FENCE, TP A	LF	100	\$5.00	\$500.00
16	MAINTENANCE OF TEMPORARY SILT FENCE, TP A	LF	100	\$5.00	\$500.00

Total Cost: \$41,022.31

20% Contingency: \$8,204.46

Construction Cost \$49,226.78

Overall Total: \$49,226.78

House Bill 581

Property Tax Relief and Reform for Georgians

HB 581 (Rep. Shaw Blackmon, 146th) was passed by the Georgia General Assembly on March 28, 2024 and signed by Governor Brian Kemp on April 18, 2024. The bill provides relief and clarity to taxpayers by offering the following: a statewide floating homestead exemption, an optional sales tax to further offset property taxes, and property tax process reforms.

THE ENTIRE BILL REQUIRES THE RATIFICATION OF A CONSTITUTIONAL AMENDMENT TO BE VOTED ON DURING THE GENERAL ELECTION ON NOVEMBER 5, 2024 (HR 1022)

MARCH 1, 2025

DATE BY WHICH LOCAL GOVERNMENTS MAY OPT OUT OF PARTICIPATING IN THE FLOATING HOMESTEAD EXEMPTION. TO OPT OUT, A LOCAL GOVERNMENT MUST PASS A RESOLUTION AND HOLD THREE PUBLIC HEARINGS.

STATEWIDE FLOATING HOMESTEAD EXEMPTION

HB 581 provides a **statewide** "floating" homestead exemption that will limit annual assessment increases on a homesteaded property to the **rate of inflation**.



The base year assessed value for a home will be initially set at the 2024 value of a home and resets whenever a home is sold or receives a substantial property change.



A rate of inflation based on the consumer price index shall be set annually by the Georgia Department of Revenue. Home assessment increases will be limited to this rate of inflation, with any excess being offset by the homestead exemption.

This statewide exemption can be used in addition to other homestead exemptions that are not base year value exemptions. If another base year exemption exists locally, the exemption of greater benefit to the homeowner shall be provided.

OPTIONAL SALES TAX FOR PROPERTY TAX RELIEF

- ✿ An optional 1 percent sales and use tax is available to eligible counties and municipalities. Proceeds may only be used for property tax relief.
- ✿ The measure must be approved by voters via referendum.

- ✿ Counties and cities may qualify by implementing an ad valorem property tax exemption (such as the floating homestead exemption above) and entering into an intergovernmental agreement that determines the distribution of proceeds.

- ✿ The tax may be levied for up to five years with the option for renewal. Any renewal will require a local act of the Georgia General Assembly in addition to the intergovernmental agreement and approval via referendum.

PROPERTY AND SALES AND USE TAX REFORMS

- ✿ Regarding property tax assessment notices: the current requirement to include an estimate of the current year's tax based on the previous year's millage rate is replaced with the current year's estimated roll-back rate. A disclaimer related to the roll-back rate is only required if the roll-back rate is not met.

- ✿ Parcels are required to be appraised at least once every three years.
- ✿ Property values may only receive a three-year lock if the value is reduced upon appeal; currently, property values can be frozen for three years if the value is reduced or remains the same when appealed.

- ✿ Local option sales and use taxes are restructured as follows:
 - ✿ The local sales tax limit remains at 2 percent.
 - ✿ An additional 1 percent may be levied from each of the following categories:
 - 1) ESPLOST
 - 2) Transportation-related sales tax
 - 3) One of OLOST, CSPLOST, MOST, or the optional sales tax for property tax relief above.

HB 581 Summary and Guidance

ACCG & GMA Joint Trainings
October 3rd, 2024

Ryan Bowersox
Assistant General Counsel, GMA

Dante Handel
Associate Director of Governmental Affairs, ACCG



Background: Where Did This Come From?



- Legislature entered 2024 session concerned about rising property value assessments and in turn property tax
- Senate leaders wanted measures to control rapid increases in property assessments
- House leaders looked to expand sales tax options
- Various proposals ultimately resulted in HB 581 (& HR 1022)

HB 581: Overview

Signed into law April 18, 2024 (Act 379).

Contingent upon November Statewide Referendum
(HR 1022)

Major Components:

- 1.Statewide Floating Homestead Exemption (Part 2)
- 2.New Local Option Sales Tax (Part 3)
- 3.Property Tax Procedural Changes (Part 1)



Presentation Outline

- When does this bill take effect?
- Who gets a floating homestead exemption?
- What is a floating homestead exemption?
- What is the procedure to opt out and what is the timeline?
- What is the new sales tax?
- Other sales tax revisions
- Other property tax changes
- Policy considerations for local governments
- Other local government considerations

When Does this Bill Take Effect?

- HB 581 is contingent upon the passage of the constitutional amendment from HR 1022 on November 5, 2024 which allows local governments the ability to opt out of the floating homestead exemption.
 - A simple majority is required for passage.
 - If the constitutional amendment fails, all of HB 581 is repealed.
 - If the constitutional amendment passes, then the bill takes effect January 1, 2025.

HB 581

Part 1: Statewide Floating Homestead Exemption

- If approved, HB 581 implements a statewide floating homestead exemption for all local governments:
 - Counties
 - Cities
 - School Boards
- A floating homestead is a special type of homestead exemption designed to offset or reduce increases in taxable value to the property.
 - It is also referred to as a base-year or value offset exemption.
 - Freezes are a type of floating homestead exemption, but do not have an annual inflationary adjustment.

How Does a Floating Homestead Exemption Work?

- It works by increasing the value of the exemption to offset inflation.
 - For example, if a property had a taxable value of \$100,000 and the taxable value increased the following year due to market changes to \$110,000, then the exemption ‘floats’ to be worth \$10,000 of taxable value so the taxpayer still pays on the original base year value of \$100,000.



How Does HB 581's Floating Homestead Exemption Work?

- The HB 581 floating homestead exemption is unique because the base year value is adjusted and will increase by a rate of inflation determined by the State Revenue Commissioner – likely CPI.
 - If we take the same property with a \$100,000 taxable base year value and CPI is 2% the following year, then the base value of \$100,000 may be increased by up to 2% to give an adjusted base year value of \$102,000. The exemption 'floats' to be worth \$8,000 of assessed value so the taxpayer would pay on a taxable value of \$102,000 in year 2.

How Does HB 581's Floating Homestead Exemption Work?

- For homes first receiving this exemption in taxable year 2025, the base year assessed value will be the 2024 assessed value.
- For homes first receiving the exemption in later years, the base year assessed value will be the assessed value for the immediately preceding year.
- Similar to other homestead exemptions, the value will be reset when the home is sold and is adjusted with “substantial property change.”
- Homeowners can not transfer exemption to new property.

How Does HB 581's Floating Homestead Exemption Work?



- The effect of HB 581's homestead exemption:
 - The taxable value of a home may only increase at a rate of inflation each year.
 - Essentially controlling this will control how much the "value" of a home can increase annually.
- Homeowners already granted a homestead will receive this exemption automatically.
- Non-homesteaded property (i.e. Commercial) will continue to be valued at fair market.

How Does this New Homestead Exemption Impact Existing Homestead Exemptions?

- This new floating homestead exemption is in addition to and not in lieu of all non-floating homestead exemptions. This will not repeal/replace existing homestead exemptions!
 - If there is an existing local floating homestead exemption, the taxpayer will receive whichever of the two exemptions is more beneficial. This is also true if a local floating homestead exemption is added in the future.
 - Existing local exemptions, such as the \$2,000 of assessed value, are added after the floating homestead exemption is calculated.

How Can a Local Government “Opt Out” of the Homestead Exemption?

- Any governing authority may elect to opt out of the floating homestead exemption created by HB 581 by following a procedure like the “public notification of tax increase” when a full rollback is not taken.
 - The local government must advertise and conduct three public hearings of intent to opt out and later adopt a resolution.
 - Must file resolution to Secretary of State by March 1, 2025!
 - If procedures are not met, opt out is not effective.

How Can a Local Government “Opt Out” of the Homestead Exemption?

- This process may not begin until the bill takes effect on January 1, 2025, and must be completed by March 1, 2025.
- A governing authority may not opt-out of the statewide floating homestead exemption after this deadline.
- However, the local delegation may pass a local Act of the General Assembly to implement a local floating homestead exemption at any time.



How Can a Local Government “Opt Out” of the Homestead Exemption?



- Important to note: The decision to opt out is independent among local governments.
- A county, the cities, and the school board may each decide whether to opt out.
- The decision of whether or not to opt out will not impact the other local government’s homestead exemption.
- This may result in homes having different taxable values.

Is the Decision to “Opt Out” or “Stay In” Permanent?

- **Yes**
- No action is needed by the local government to have the homestead exemption apply if it is approved in November.
 - Once the opt out period has passed, currently there is no future method to opt out.
- If a local government opts out, there is no future method to opt in to the HB 581 exemption.
 - Of course, a similar homestead exemption can still be done in traditional manner.

HB 581 Timeline

November 5, 2024: Statewide Question on Constitutional Amendment

January 1, 2025: HB 581 takes effect, if approved

March 1, 2025: Deadline for local governments to “opt out” of homestead exemption

HB 581

Part 2: Sales Tax Revisions and FLOST

- HB 581 makes two major changes to local sales tax:
- Revises the provisions of O.C.G.A. 48-8-6 which limits the percentage of local sales tax a jurisdiction may levy.
- Creates new local option sales tax contingent upon jurisdictions having a base year value homestead exemption.



Revised Local Sales Tax Limitation

- This legislation revises the existing two percent local sales tax cap; exemptions now include:
 - ESPLOST
 - Up to one percent of the transportation sales taxes, which include:
 - Regional TSPLOST
 - Single-County TSPLOST
 - Transit SPLOST
 - MARTA
 - One of the specialty pennies, including:
 - **The new sales tax for property tax relief created by HB 581**
 - Columbus-Muscogee and Macon-Bibb OLOST
 - Augusta-Richmond Coliseum SPLOST
 - MOST for Atlanta and cities connected to its water system (East Point, College Park, and Hapeville)

What is the New Sales Tax?

- A new sales tax is created for the limited purpose of property tax relief – it may be levied in 0.05 percent increments up to one percent.
- To be eligible to levy the tax, **both the county and all cities within the county that levy a property tax** must have in effect a floating homestead exemption: either the one created by this bill or a local floating homestead exemption.
 - It does not matter if the school boards opt out or not since they are ineligible to share in the proceeds of the tax without a separate constitutional amendment.

How is the New Sales Tax Implemented?

- The county and city/cities representing at least fifty percent of the municipal population of cities that levy a property tax must enter into an intergovernmental agreement (IGA) calling for the tax.
- The IGA shall specify the rate, duration (not to exceed five years), and the distribution between the county and cities. It will also set the ballot question.



How is the New Sales Tax Implemented?



- Following the adoption of the IGA, the tax must be approved through local referendum.
- Approval by the voters will be required to levy the sales tax.
- This is a different vote than the one that occurs in November approving the constitutional amendment!

How are Cities Not on the IGA Treated?

- The IGA must also specify a portion of the proceeds that the cities not on the IGA will receive.
- Must not be less than the proportion the absent municipality's population bears to the total population of all cities within the county that levy a property tax.
 - Modelled after LOST absent municipality provisions.



How are MOST Cities Treated?

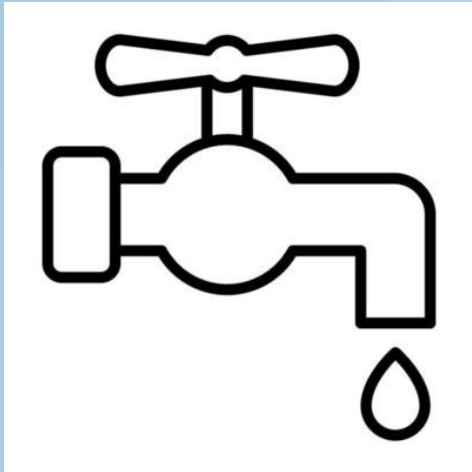

- Cities levying a MOST (Municipal Option Sales Tax for Water and Sewer Projects) are excluded.
- Will not be considered for eligibility and are not included in these calculations.
- Tax will not be collected within the city and city can not receive the proceeds of this tax.
- Currently Atlanta, East Point, College Park, & Hapeville.

How is the New Tax Collected and Distributed?

- Collection of the tax will begin at the start of the next calendar quarter beginning more than 50 days after that date (as opposed to eighty days for other local sales taxes).
- The Georgia Department of Revenue (DOR) sends the money to the county and the county will be responsible for distributing the money to the cities in accordance with the IGA.

How Can the Tax Be Renewed?

- The tax can run up to 5 years.
- Prior to the expiration, if the local governments want to renew, it requires:
 - Passage of a local Act calling for the reimposition of the tax.
 - A new IGA between the county and eligible number of cities.
 - A new referendum to approve the tax by the voters.
- Talk to your local delegation!

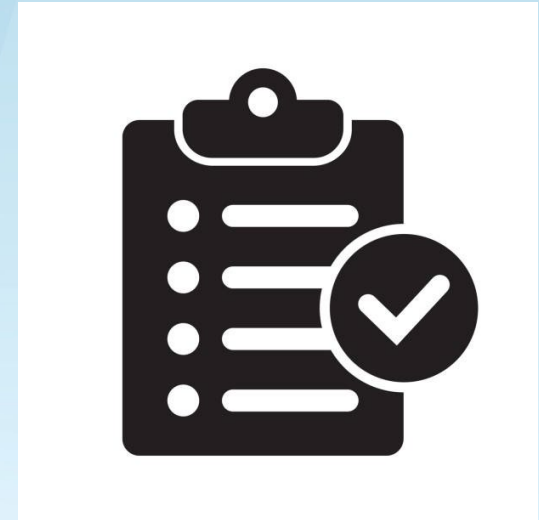

How are Funds From the New Sales Tax Used?

- Funds must be used exclusively for property tax relief.
- Each taxpayer's property tax bill shall state the amount by which property tax has been reduced because of the imposition of this tax.
- The roll-back rate shall be reduced annually by the millage equivalent of the net proceeds of this new tax received by the political subdivision during the prior taxable year.
- If any political subdivision is not in compliance with the use of the proceeds from this tax, then the State Revenue Commissioner shall not certify the tax digest of that political subdivision until it comes into compliance.

HB 581

Part 3: Procedural Property Tax Changes

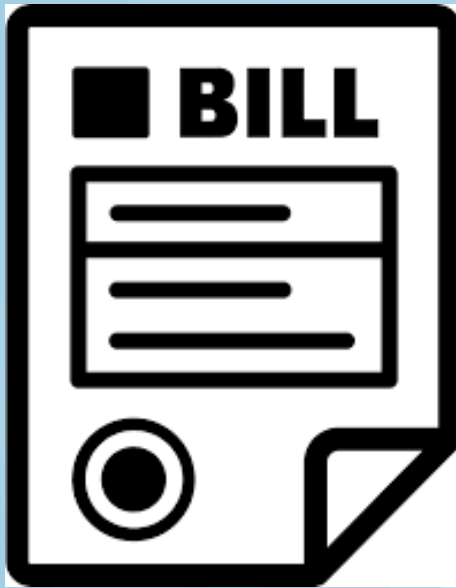

- Created an “estimated roll-back rate” which is certified to the tax commissioner/collector by the local governments.
- The estimated roll-back rate is required to be included on the assessment notice, replacing the previous year’s millage rate.
 - Designed to attempt to allow local government to give more accurate estimate of what tax liability will be.

HB 581

Part 3: Procedural Property Tax Changes

- This gives local governments broad flexibility to set this rate wherever they deem appropriate.
 - This does not need to be the same millage rate as the rollback rate for taxpayer bill of rights.
- If the adopted millage rate exceeds the estimated roll-back rate, then a disclaimer is included on the tax bill stating the name of the governing authority that exceeded the estimated roll-back rate and that this will result in an increase of taxes owed.

HB 581

Part 3: Procedural Property Tax Changes

- Removed the provision that the sale price is the maximum allowable fair market value in the next taxable year.
 - This provision caused the Department of Audits and Accounts (DOAA) to change their sales ratio study methodology when it was originally passed in 2010, so this change will improve the sales ratio study and prevent penalties on local governments and their taxpayers.
- This legislation also allows the Board of Assessors to appeal the sales ratio study directly instead of requiring a local government to appeal on their behalf.

HB 581

Part 3: Procedural Property Tax Changes

- Modifying the three-year lock for appeals so the taxpayer only receives the lock if they receive a value reduction upon appeal.
- Updating the settlement conference statute so that if neither the taxpayer nor their representative participates in good faith, then the taxpayer shall not receive the benefit of the temporary 15 percent reduction in taxes owed and shall not be awarded attorney's fees.
- Requiring that the chief appraiser ensure that every parcel in the county be appraised at least every three years.

Policy Considerations for Local Governments

- As with any other local government choice, this is a policy decision with pros and cons to be considered.
- The floating homestead exemption rewards homeowners, especially those that reside in the community for a long period of time after this legislation takes effect.
- Taxes do not disappear – they only shift: in this instance, the taxes are shifting from homestead properties to all other property types (commercial, agricultural, industrial, residential non-homestead).

Policy Considerations for Local Governments

- Taxation is a formula: taxable value multiplied by the millage rate gives the property tax revenue to meet local budgets.
 - Since the floating homestead exemption slows the growth in value for residential homestead properties, it will create some upward pressure on the millage rate. The effects of a floating homestead increase over time, so this will have a smaller impact in the early years and a larger impact in the later years.
- Counties and cities may more easily increase the millage rate if needed than schools due to the 20-mill cap, which may only be exceeded after the successful passage of a local referendum.

Other Local Government Considerations

- Each local government (counties, cities, and schools) may independently decide whether to opt out.
- This decision does not impact the homestead exemptions but cities and counties can impact eligibility for the FLOST.
- Every local government has a unique digest mix of property types. Local officials are encouraged to contact their Chief Appraiser for information regarding their specific situation. Some communities will better be able to support a floating homestead exemption than others.

Other Local Government Considerations

- The referendum is likely to be very popular and citizens may not understand a local government's decision.
- Even if your local government decides to opt out of the HB 581 floating homestead exemption, nothing precludes your local delegation of the General Assembly from passing a local Act putting a local floating homestead to referendum in your jurisdiction.
- If a local government decides to opt out, it may be best practice to explain this decision to the public and the local delegation.

Other Local Government Considerations

- Many jurisdictions have existing floating homestead exemptions. These typically apply only to M&O millage rates, but not to special service districts (SSDs).
 - The HB 581 floating homestead exemption applies to special service districts in addition to M&O but does not apply to bond millage.
 - If a local government that has a floating homestead exemption already in place does not opt out, then their special service districts will be affected by the new floating homestead exemption.
- A local government may consider opting out to avoid confusion.

Other Local Government Considerations

- While the decision to opt out of the floating homestead exemption is independent, instituting the new sales tax requires collaboration between the county and cities.
- The county and all cities in the county that levy a property tax must have a base year homestead exemption in place (statewide or through a local Act).
- The county and cities should discuss the option of the sales tax before expiration of the opt out period.
- Know the distribution is determined by the IGA, so this should be discussed early.
- A local Act is required for renewal, so involve your local delegation.

Next Steps....

- Joint ACCG-GMA Webinar Oct. 16th (live and recorded).
 - This will be the same presentation
- Joint Guidance Document/FAQ released today!
 - Document on GMA's Website
 - Link to ACCG HB 581 page:
 - [ACCG Advancing Georgia's Counties](#)



Contact Us

Ryan Bowersox
Assistant General Counsel, GMA
rbowersox@gacities.com

Dante Handel
Associate Director of Governmental Affairs, ACCG
Dhandel@accg.org





December 16, 2024

Mr. Bill Andrew, City Manager
City of Oxford
110 W Clark Street
Oxford, GA 30054

Mr. Andrew:

The following is our understanding of the proposed scope of work and fees related to plan revisions for the lighting design for City of Oxford, Georgia Whatcoat Street Realignment Project:

Civil Engineering – Site Lighting

Project Description:

AtkinsRéalis has prepared the Construction Documents for the realignment of the existing intersection of Whatcoat Street, and W. George Street at the common intersection with N. Emory Street/GA Highway 81 in Oxford, Georgia. The City of Oxford has indicated that they may elect to revise the scope to include street lighting and pedestrian lighting.

AtkinsRéalis will provide the services as follows:

I. Lighting Design and Power Plan as a Revision to the 100% Construction Documents:

AtkinsRéalis will perform the site lighting design and provide supplemental plans. The overall Construction Documents will be updated to coordinate with the lighting plans. ***A Lump Sum fee of \$20,000.00 is proposed for the plan revisions.***

It is anticipated that revisions to the following plans may be required:

1. Cover Sheet
2. Mainline Plan
3. General Electrical Notes
4. Demo Plans
5. Lighting Layout Plans and Schedules
6. Power and Circuit Plans
7. Lighting and Power Details
8. QA/QC of revised plans

Also included is a total of 4 hours of coordination with the City of Oxford, which includes a maximum of 4 hours of conference calls and/or Teams Meetings. No in-person meetings are included within the scope.

Assumptions & Exclusions:

1. Includes all previously provided assumptions and exclusions from the original scope and subsequent change orders, except for the sight lighting design.

Sincerely,

A handwritten signature in blue ink, appearing to read "G. Kakunes".

George N. Kakunes, P.E., PMP
Sr. Project Manager



**Attachment 'B' - Hourly Rate Schedule
(Effective through 12/31/2024)**

CIVIL ENGINEERING FEES

CLASSIFICATION

HOURLY RATE

Project Principal	\$ 260.00 to \$280.00
Project Director	\$ 235.00 to \$255.00
Senior Professional	\$ 200.00 to \$220.00
Senior Civil/Electrical Project Manager	\$ 228.00 to \$254.00
Project Manager	\$ 166.00 to \$176.00
Senior Engineer IV	\$ 198.00 to \$210.00
Senior Engineer III	\$ 186.00 to \$196.00
Senior Engineer II	\$ 158.00 to \$170.00
Senior Engineer I	\$ 124.00 to \$138.00
Engineer III	\$ 120.00 to \$128.00
Engineer II	\$ 112.00 to \$124.00
Engineer I	\$ 105.00 to \$116.00
Senior Designer III/GIS Operator	\$ 180.00 to \$200.00
Senior Designer II/GIS Operator	\$ 158.00 to \$178.00
Senior Designer I/GIS Operator	\$ 125.00 to \$154.00
CAD Designer II /Technician	\$ 106.00 to \$120.00
CAD Designer/Technician	\$ 80.00 to \$92.00
Operations/Admin Coordinator	\$ 60.00 to \$80.00

Mileage per the Federal rates in force at the time of service 0.67/mile

TRAIL PLAN A - ORIGINAL

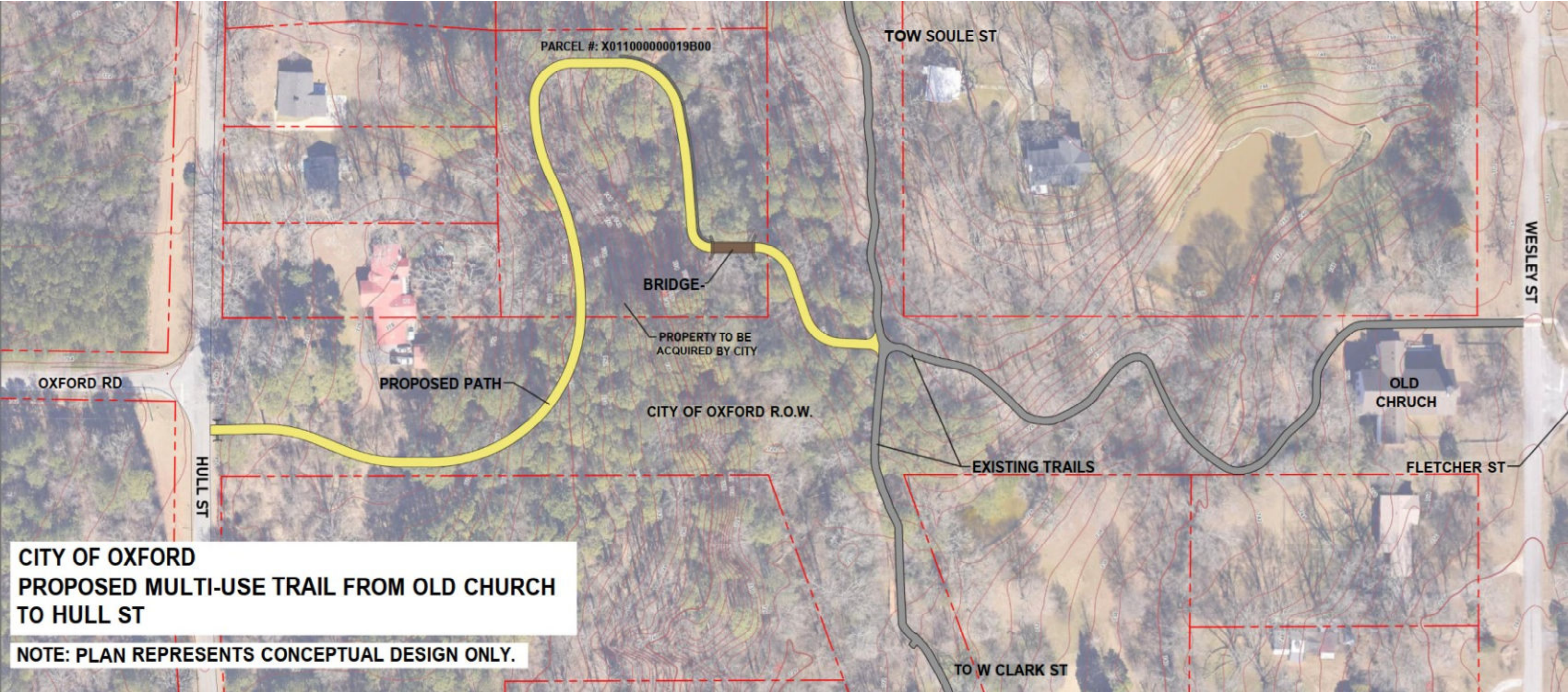

**CITY OF OXFORD
PROPOSED MULTI-USE TRAIL FROM OLD CHURCH
TO HULL ST**

NOTE: PLAN REPRESENTS CONCEPTUAL DESIGN ONLY.

OXFORD RD

TRAIL HEAD

CITY OF OXFORD R.O.W.

TO SOULE STREET

TO OLD CHURCH

1008 HULL ST
P# X011000000023000
OWNER: CHANEY LONZA ESTATE

POSSIBLE ADDITIONAL
R.O.W. OR PERMANENT
EASEMENT REQUIRED

CITY OF OXFORD R.O.W.

EXISTING TRAIL

402 CLARK ST

EXISTING
SANITARY
SEWER

PROPOSED STORM
PROPOSED WALL

EXISTING POWER LINE

PROPOSED PATH

W CLARK ST

EXISTING RAISED CROSSWALK
EXISTING TRAIL

**CITY OF OXFORD
PROPOSED MULTI-USE TRAIL
FROM OLD CHURCH
TO HULL ST ALTERNATE DESIGN**

NOTE: PLAN REPRESENTS CONCEPTUAL DESIGN ONLY.

OXFORD TRAIL 3 - cost comparisons major items from original design to current design (01/08/2025)

ITEM (* items compared)	A.TRAIL ORIGINAL (1.5 AC) (trail through parcel across creek)	B.TRAIL CURRENT (0.5 AC) (trail along Clark/Hull Street)	COMPARISON NOTES
TRAFFIC CONTROL	\$20,000.00	\$35,000.00	more traffic on roadway for B. more grading of land on A. addition of bridge and longer trail on A.
GRADING COMPLETE	\$275,000.00	\$150,000.00	
EROSION CONTROL ITEMS *creek-original trail plus more length	\$65,250.00 *	\$18,425.00	
CONCRETE * 10 ft. trail - original *12 ft. trail current	\$157,020.00 *	\$185,950.00 *	B. with 12 ft. trail more expense even though not as long as A.
RETAINING WALLS *add BRIDGE - original trail	\$223,350.00 *	\$145,200.00	A. has more walls due to topography and accessibility for trail
STORM DRAINAGE *additional piping - current trail	\$35,625.00	\$66,425.00 *	B. additional storm along roadway
LANDSCAPE ITEMS * seed mix - original trail *trees- current trail	\$27,604.00 *	\$51,585.00 *	additional tree planting on B.
MISC ITEMS * original trail -property acquisition * current trail - power pole relocations	\$120,000.00 *	\$135,000.00 *	A. need to acquire property, B. will require easement and power line (pole) relocations
subtotals:	\$923,849.00	\$787,585.00	estimated difference on costs